

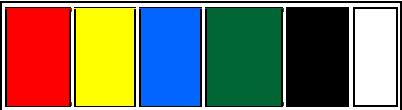
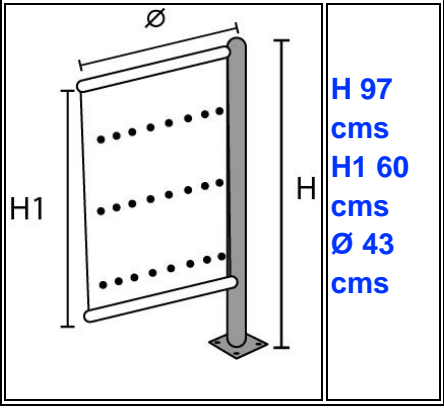

Botes de Basura Urbanos para Parques y Empresas

Botes de Basura Urbanos

Botes de Basura para áreas Publicas al mejor Precio

Foto/ Picture	Modelo PI-BS-020,BOTE AMALFI-BTAMS001.	Precio/Price
	<p>Acabado: Pintura electrostática con pretratamiento de fosfato de zinc y/o sandblast. Material: Acero al carbón. Capacidad: 82 L Colores:</p>   <p>H 97 cms H1 60 cms Ø 43 cms</p> <p>Anclaje: Atornillar o ahogar en cemento.</p>	<p>\$3,712.00 Neto</p>
Foto/ Picture	Modelo PI-BS-021, Bote Amalfi Doble - BTAMS002	Precio/Price



Botes de Basura Urbanos para Parques y Empresas

	<p>Acabado: Pintura electrostática con pretratamiento de fosfato de zinc y/o sandblast.</p> <p>Material: Acero al carbón.</p> <p>Capacidad: 82 L</p> <p>Colores:</p> <p>H 97 cms H1 60 cms Ø 43 cms A: 93 CMS</p> <p>Anclaje: Atornillar o ahogar en cemento.</p>	<p>\$6,380.00 Neto</p>
<p>Foto/ Picture</p>	<p>Modelo PI-BS-001, SICILIA-BTSCS001.</p>	<p>Precio/Price</p>

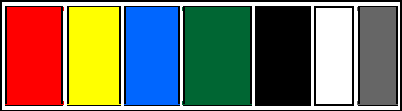
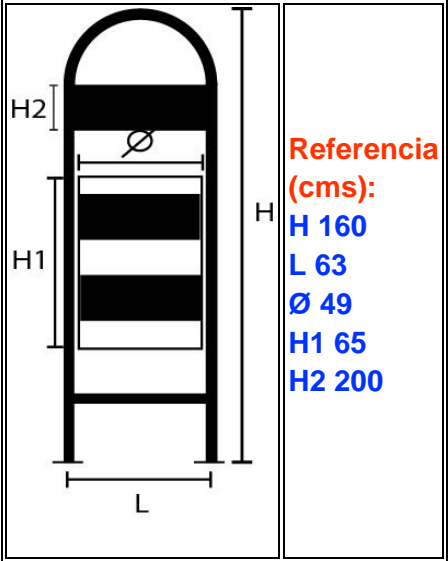

Botes de Basura Urbanos para Parques y Empresas

	<p>Capacidad: 130 L.</p> <p>Acabado: Pintura electrostática con pretratamiento de fosfato de zinc y/o sandblast.</p> <p>Material: Acero al carbón.</p> <p>Colores:</p>   <p>Referencia (cms): H 160 L 63 Ø 49 H1 65 H2 200</p> <p>Anclaje: Atornillar o ahogar en cemento. Vaciado: Abatible o fijo.</p>	<p>\$ 5,104.00 NETO</p>
<p>Foto/ Picture</p>	<p>Modelo PI-BS-002, NAPOLI DOBLE-BTNPD002</p>	<p>Precio/Price</p>

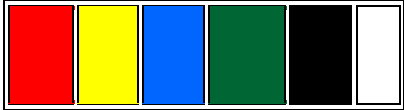
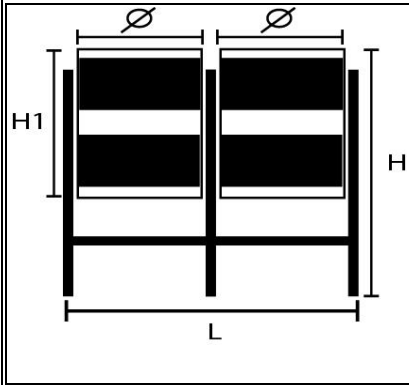

Botes de Basura Urbanos para Parques y Empresas

	<p>Capacidad: 130 L. por bote, 260 L. total. Acabado: Pintura electrostática con pretratamiento de fosfato de zinc y/o sandblast. Material: Acero al carbono. Colores:</p>   <p>Referencia (cms): H 95 L 120 Ø 49 H1 65</p> <p>Anclaje: Atornillar o ahogar en cemento. Vaciado: Abatible o fijo.</p>	<p>\$ 7,946.00 NETO</p>
<p>Foto/ Picture</p>	<p>Modelo:PI-BS-019,Capri-BTCAS001</p>	<p>Precio/Price</p>

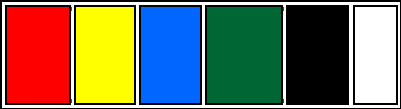
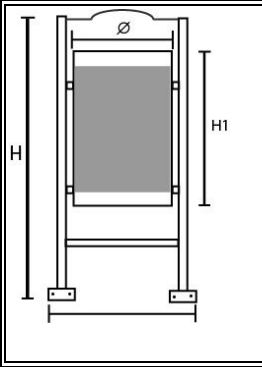

Botes de Basura Urbanos para Parques y Empresas

	<p>Capacidad: 61 L.</p> <p>Acabado: Pintura electrostática con pretratamiento de fosfato de zinc y/o sandblast.</p> <p>Material: Acero al carbón.</p> <p>Colores:</p>   <p>Referencia (cms): H 1: 120 L: 53.0 Ø 36.0 H1: 58.5</p> <p>Anclaje: Atornillar ó ahogar en cemento. Vaciado: Tapa fija con bote abatible o´ tapa abatible con bote fijo.</p>	<p>\$3,484.64 Neto.</p>
<p>Foto/ Picture</p>	<p>Modelo. PI-BS-004, Bote Burano-BTRS001</p>	<p>Precio/Price</p>



Botes de Basura Urbanos para Parques y Empresas

	<p>Capacidad: 61 L.</p> <p>Acabado: Pintura electrostática con pretratamiento de fosfato de zinc y/o sandblast.</p> <p>Material: Acero al carbono.</p> <p>Colores: Amplia variedad.</p>   <p>Referencia (cms): H 975 L 530 Ø 360 H1 585</p> <p>Anclaje: Atornillar o ahogar en cemento. Vaciado: Abatible o fijo.</p>	<p>\$ 3,190.00 NETO</p>
<p>Foto/ Picture</p>	<p>Modelo. PI -BS-005. Bote Siena Doble - BTSED002</p>	<p>Precio/Price</p>

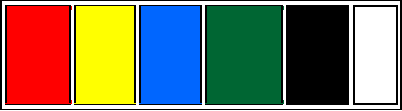
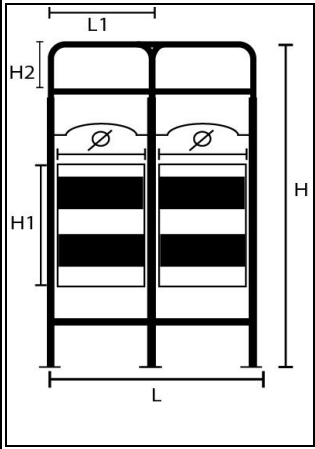

Botes de Basura Urbanos para Parques y Empresas

	<p>Capacidad: 61 L. por bote, 122 L. total. Acabado: Pintura electrostática con pretratamiento de fosfato de zinc y/o sandblast. Material: Acero al carbono. Colores:</p>   <p>Referencia (cms): H 160 L 95 L1 42 Ø 36 H1 58 H2 250</p> <p>Anclaje: Atornillar o ahogar en cemento. Vaciado: Se recomienda abatible.</p>	<p>\$ 6,728.00 NETO</p>
<p>Foto/ Picture</p>	<p>Modelo. PI -BS-006-BOTE SIENA-BTSES001</p>	<p>Precio/Price</p>

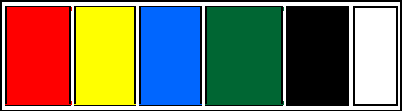
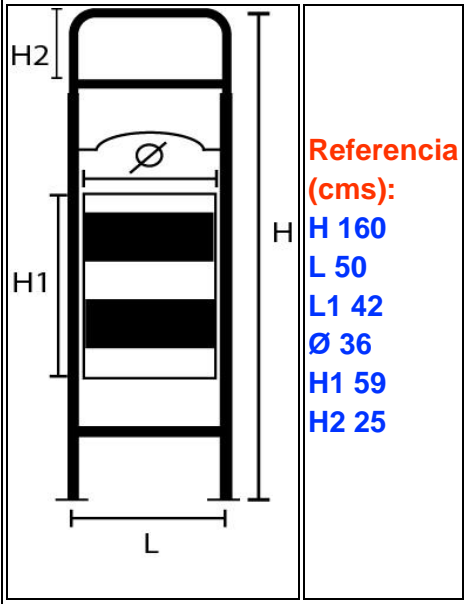

Botes de Basura Urbanos para Parques y Empresas

	<p>Capacidad: 61 L.</p> <p>Acabado: Pintura electrostática con pretratamiento de fosfato de zinc y/o sandblast.</p> <p>Material: Acero al carbón.</p> <p>Colores:</p>   <p>Referencia (cms):</p> <p>H 160 L 50 L1 42 Ø 36 H1 59 H2 25</p> <p>Anclaje: Atornillar o ahogar en cemento. Vaciado: Se recomienda abatible.</p>	<p>\$ 4,408.00 NETO</p>
<p>Foto/ Picture</p>	<p>Modelo. PI-BS-008, Bote Murano Doble-BTMRD002</p>	<p>Precio/Price</p>

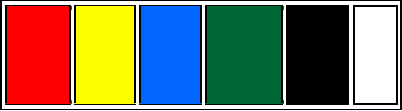
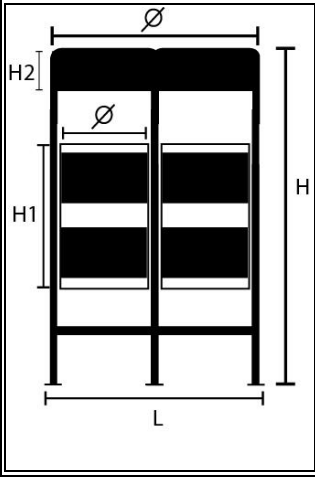

Botes de Basura Urbanos para Parques y Empresas

	<p>Capacidad: 61 L. por bote, 122 L. total. Acabado: Pintura electrostática con pretratamiento de fosfato de zinc y/o sandblast. Material: Acero al carbono. Colores:</p>   <p>Referencia (cms): H 160 L 95 L1 84 Ø 36 H1 59 H2 25</p> <p>Anclaje: Atornillar o ahogar en cemento. Vaciado: Abatible o fijo.</p>	<p>\$ 8,560.00 NETO</p>
<p>Foto/ Picture</p>	<p>Modelo. PI-BS-009, Bote Murano-BTMRS001.</p>	<p>Precio/Price</p>

Botes de Basura Urbanos para Parques y Empresas

PI-BS-009

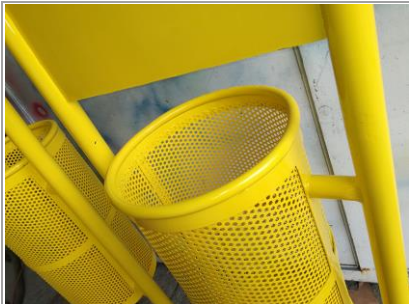

Capacidad: 61 L.

Acabado: Pintura electrostática con pretratamiento de fosfato de zinc y/o sandblast.

Material: Acero al carbono.

Colores:

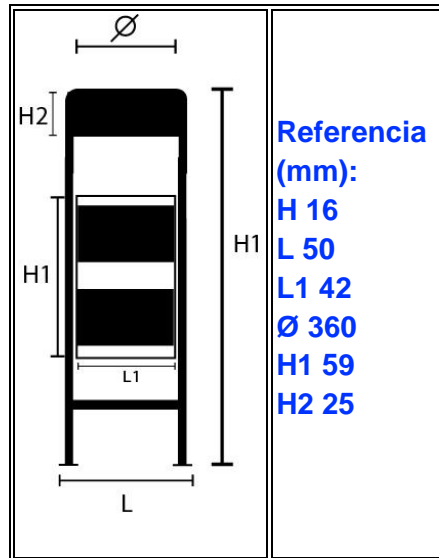
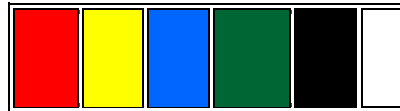

Anclaje: Atornillar o ahogar en cemento.

Vaciado: Abatible o fijo.

\$ 6,194.40
NETO



Ver Video 1



Botes de Basura Urbanos para Parques y Empresas



[Ver Video 2](#)

Foto/ Picture

Modelo. PI-BS-010

Precio/Price



Botes de Basura Urbanos para Parques y Empresas

	<p>BOTE METALICO REDONDO DE LAMINA PERFORADA TRIPLE Tuberia de acero a carbon, lamina galvanizado. 95 cms de Altura X X 65 cms de Diametro de Cada uno de los botes X 390 lts de Capacidad.</p>	<p>\$9,446.11 NETO</p>
<p>Foto/ Picture</p>	<p>Modelo. PI-BS-012, Sicilia Doble-BTSCD002</p>	<p>Precio/Price</p>
	<p>Capacidad: 130 L. por bote, 260 L. total. Acabado: Pintura electrostática con pretratamiento de fosfato de zinc y/o sandblast. Material: Acero al carbón. Colores:</p>	<p>\$8,468.00 NETO</p>
	<p>Referencia (cms): H 160 L 120 L1 50 Ø 49 H1 65 H2 20</p>	



Botes de Basura Urbanos para Parques y Empresas

	<p>Anclaje: Atornillar o ahogar en cemento. Vaciado: Abatible o fijo.</p>	
<p>Foto/ Picture</p>	<p>Modelo. PI-BS-013, Capri Doble- BTCAD002</p>	<p>Precio/Price</p>

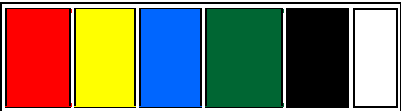
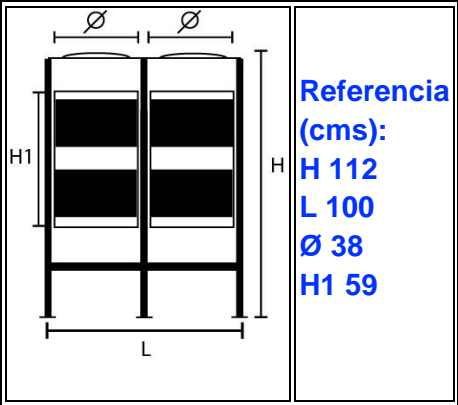

Botes de Basura Urbanos para Parques y Empresas

	<p>Capacidad: 61 L. por bote, 122 L. total.</p> <p>Acabado: Pintura electrostática con pretratamiento de fosfato de zinc y/o sandblast.</p> <p>Material: Acero al carbono.</p> <p>Colores:</p>   <p>Referencia (cms): H 112 L 100 Ø 38 H1 59</p> <p>Anclaje: Atornillar o ahogar en cemento. Vaciado: Tapa fija con bote abatible o tapa abatible con bote fijo.</p>	<p>\$5,022.80 NETO</p>
<p>Foto/ Picture</p>	<p>Modelo. PI-BS-014-Bote Parma - BTPR001</p>	<p>Precio/Price</p>



Botes de Basura Urbanos para Parques y Empresas



Capacidad: 61 L.

Acabado: Pintura electrostática con pretratamiento de fosfato de zinc y/o sandblast.

Material: Acero al carbono.

Colores:

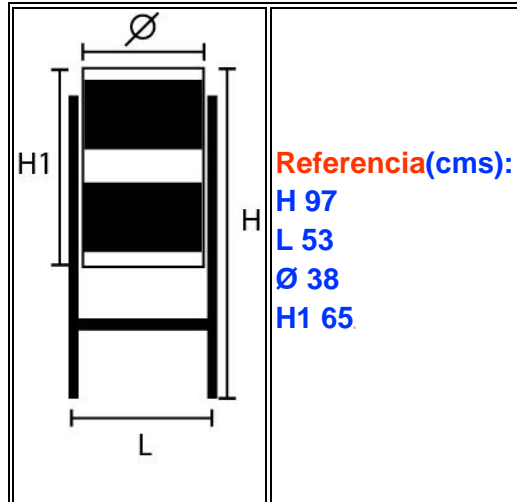
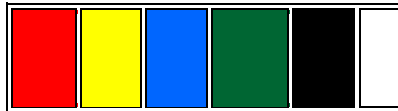

**\$3,364.00
NETO**

Anclaje: Atornillar o ahogar en cemento.

Vaciado: Abatible o fijo.

**BOTE METALICO
REDONDO DE LAMINA
PERFORADA SENCILLO**



Botes de Basura Urbanos para Parques y Empresas

Foto/ Picture	Modelo. PI-BS-015, SICILIA BTSCD004	Precio/Price
	<p style="text-align: center;"><u>VIDEO</u></p> <div style="text-align: center;"></div>	



Botes de Basura Urbanos para Parques y Empresas

	<p>BOTE METALICO REDONDO DE LAMINA PERFORADA SENCILLO Tuberia de acero a carbon, lamina galvanizado. 1.60 mts de Altura x 1.21 Mts de Largo x 49cms de Diametro del bote x 130 lts de capacidad.</p>	<p>\$8,560.00 NETO</p>
<p>Foto/ Picture</p>	<p>Modelo. PI-BS-016-Bote Napoli - BTNPS001</p>	<p>Precio/Price</p>

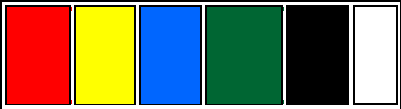
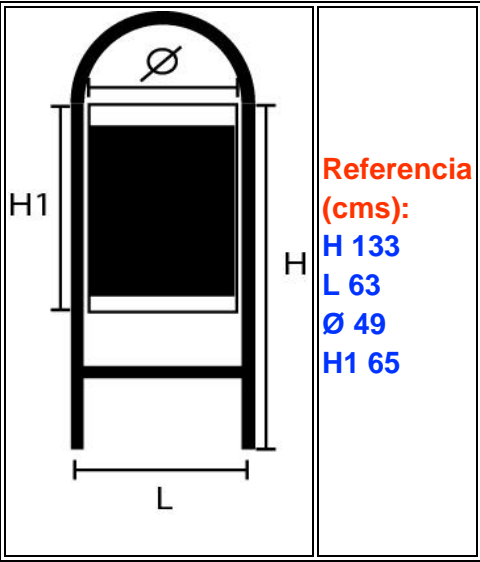

Botes de Basura Urbanos para Parques y Empresas

	<p>Capacidad: 130 L. Acabado: Pintura electrostática con pretratamiento de fosfato de zinc y/o sandblast. Material: Acero al carbono. Colores:</p>  <div style="display: flex; align-items: center; justify-content: center;">  <div style="margin-left: 20px;"> <p>Referencia (cms): H 133 L 63 Ø 49 H1 65</p> </div> </div> <p>Anclaje: Atornillar o ahogar en cemento. Vaciado: Abatible o fijo.</p>	<p>\$4,174.84 NETO</p>
<p>Foto/ Picture</p>	<p>Modelo. PI-BS-016-Bote Bote Rimini - BTRMS001</p>	<p>Precio/Price</p>



Botes de Basura Urbanos para Parques y Empresas

	<p>Capacidad: 61 L. Acabado: Pintura electrostática con pretratamiento de fosfato de zinc y/o sandblast. Material: Acero al carbono. Colores:</p> <p>Referencia (cms): H 132 L 52 Ø 36 H1 59</p> <p>Anclaje: Atornillar o ahogar en cemento. Vaciado: Abatible o fijo.</p>	<p>\$3,132.00 NETO</p>
<p>Foto/ Picture</p>	<p>Modelo. PI-BS-017-Burano Doble BTBRD002</p>	<p>Precio/Price</p>



Botes de Basura Urbanos para Parques y Empresas



Capacidad: 61 L. por bote, 122 L. total.

Acabado: Pintura electrostática con pretratamiento de fosfato de zinc y/o sandblast.

Material: Acero al carbón.

Colores:

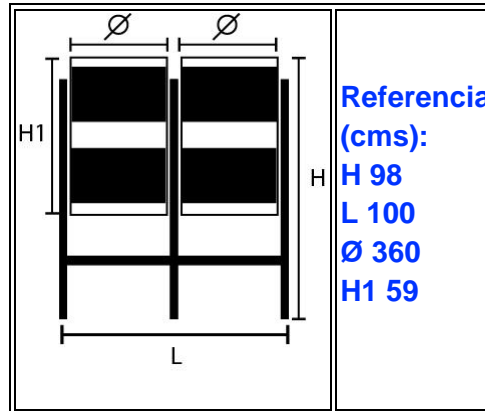
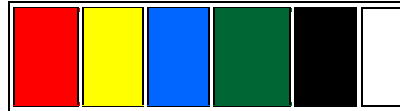

Anclaje: Atornillar o ahogar en cemento.

Vaciado: Abatible o fijo.